

NADIR2/...

Nadir



Art. NADIR2/C

Descrizione: / Description:

Plafoniera di forma quadrata in gesso o in cemento.

/ Plaster or cement ceiling lamp square shape.

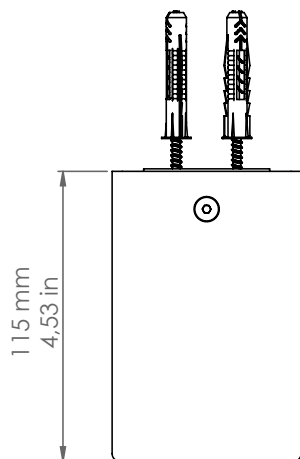
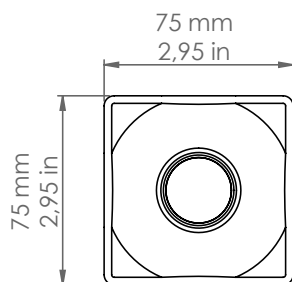

NADIR2/...

DATI TECNICI: / TECHNICAL DATA:



SORGENTE LUMINOSA: / LIGHT SOURCE:

1 x 1,2W LED
230V - 50Hz
94 lm
3000°K
350 mA
CRI: >90
50000H

DRIVER INCLUSO
/ DRIVER INCLUDED

DIMMERAZIONE: NO
DIMMING:

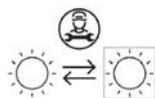

Sorgente luminosa sostituibile da un professionista
/ Replaceable light source by a professional

MATERIALE: Gesso (NADIR2/G) o cemento (NADIR2/C)
/ MATERIAL: Plaster (NADIR2/G) or cement (NADIR2/C)

VOLUME [M³]: 0,01

PESO LORDO [Kg]: 1,328 (NADIR2/G), 1,24 (NADIR2/C)
/ GROSS WEIGHT [Kg]:

Altri modelli: / Other models:

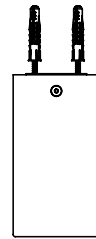
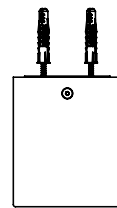
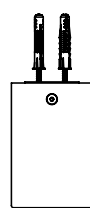
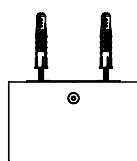
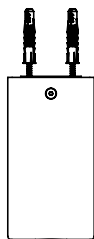
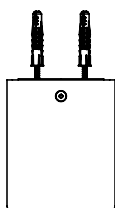
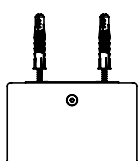
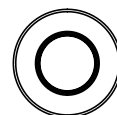
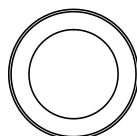
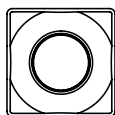
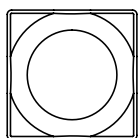

120 mm
4,72 in

100 mm
3,94 in

80 mm
3,15 in

Ø 120 mm
Ø 4,72 in

Ø 75 mm
Ø 2,95 in

Ø 100 mm
3,94 in

Ø 80 mm
Ø 3,15 in

NADIR1/... NADIR3/... NADIR5/... NADIR8/... NADIR9/... NADIR10/... NADIR12/...